

SWO(N) Community Brief



CAPT Justin Smith
LCDR Dyuti Das
LCDR Audrey Michelli
LT Matt Ponzi

Revised 21 May 2026

Career Management Team



- **CAPT Justin Smith, Head SWO(N) Assignments, PERS 424 / 41N**
 - CO/XO, USS MASON (DDG 87)
 - REA, USS RONALD REAGAN (CVN 76); OPS, USS O’KANE (DDG 77)
 - SWO(N) detailing and placement – Post PA and senior
 - Coordinates with PERS 43 on CVN XO/CO placement
- **LCDR Dyuti Das, SWO(N) Detailer, PERS 412N**
 - RTA, USS THEODORE ROOSEVELT (CVN 71); WEPS, USS KIDD (DDG 100)
 - SWO(N) detailing and placement – PA and junior
- **LCDR Audrey Michelli, SWO(N) Programs Administration and Execution, PERS 424A**
 - RTA, USS GEORGE H. W. BUSH (CVN 77); OPS, USS CARNEY (DDG 64)
 - Community tracking and monitoring, nominations, pay, AQD Mgmt, NR liaison
- **LCDR Brian Danley, SWO(N) Program Manager, OPNAV N133C2**
 - MPA, USS NIMITZ (CVN 68); OPS, USS KIDD (DDG 100)
 - Policies, Instructions, Lateral Transfer
- **LT Matt Ponzi, SWO(N) 1st Tour and SWO New Accessions Detailer, PERS 412O**
 - RL Divo, USS GEORGE H. W. BUSH (CVN 77), Strike Divo, USS MITSCHER (DDG 57)
 - Details all SWO New Accessions and SWO(N)s to Nuclear Power School

Your SWO(N) Career Advocates!

“Tactical” and “Nuclear” Career Management



- Take a **PROACTIVE APPROACH** to career management.
- Make **INFORMED** career decisions.
- **COMMUNICATE** your goals, intentions, and desires with **YOUR TEAM.**

We are Support Staff for YOUR Career Management!

Detailing Triad



- Homeport/Ship Type/Billet
- Deploying Ship
- Geographic Stability
- Graduate/Joint Education

- Qualifications
- Timing for Screening
- Career Progression
- Assignment Diversity

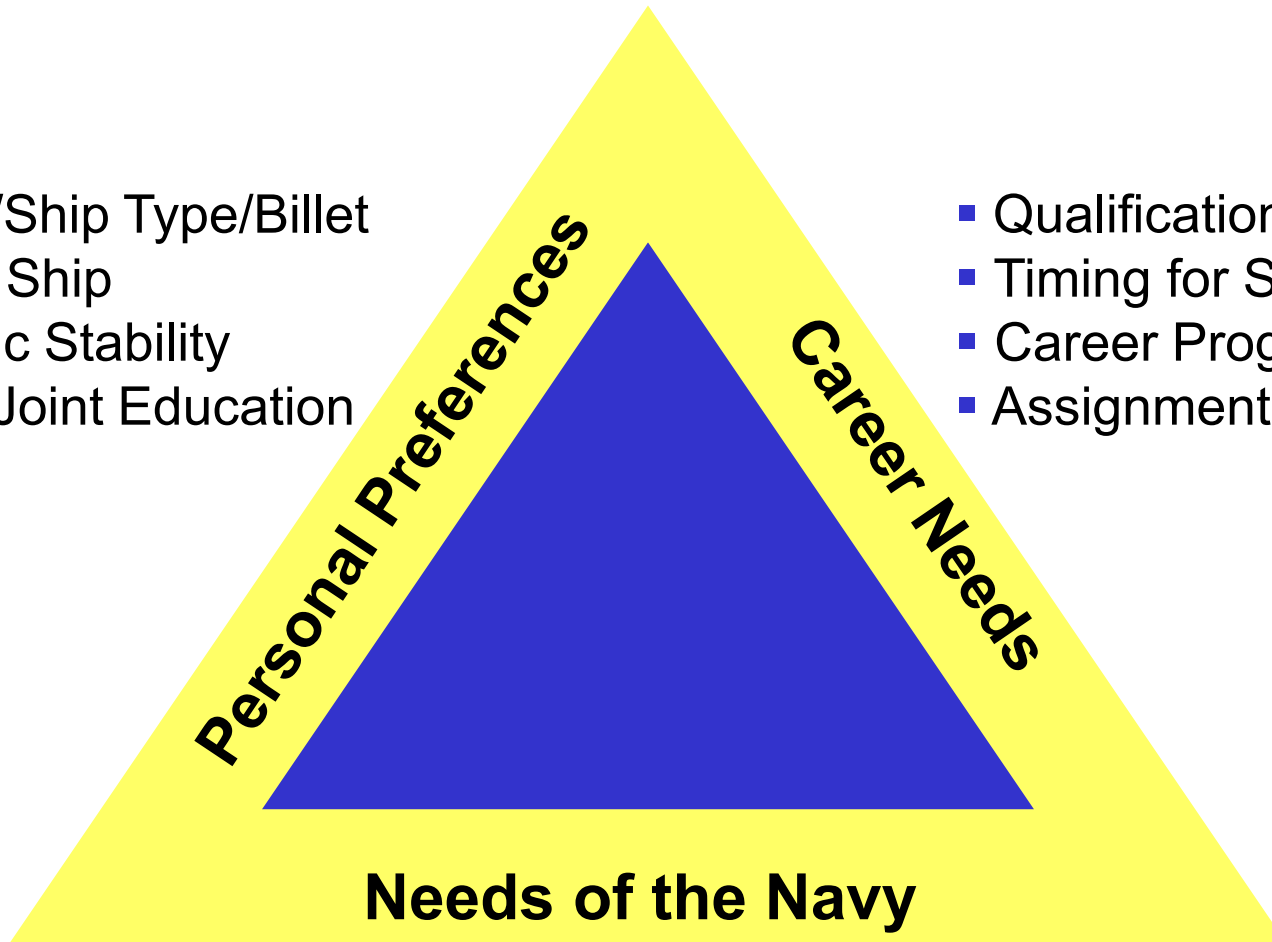

Deliver the Right Skills, at the Right Time, for the Right Job

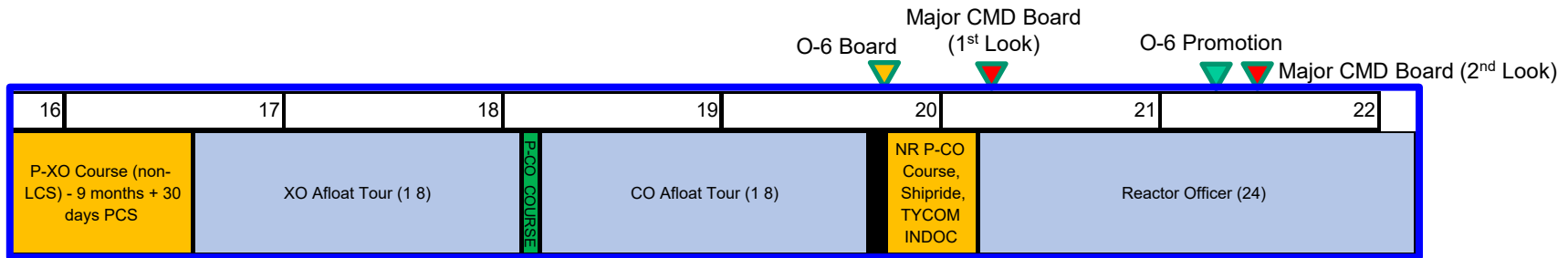
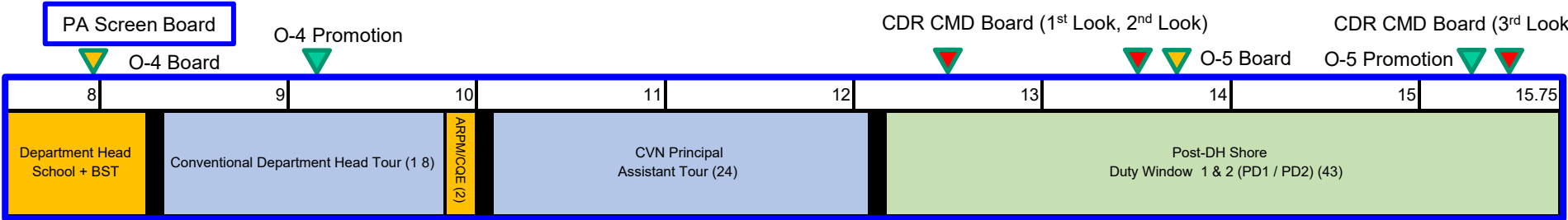
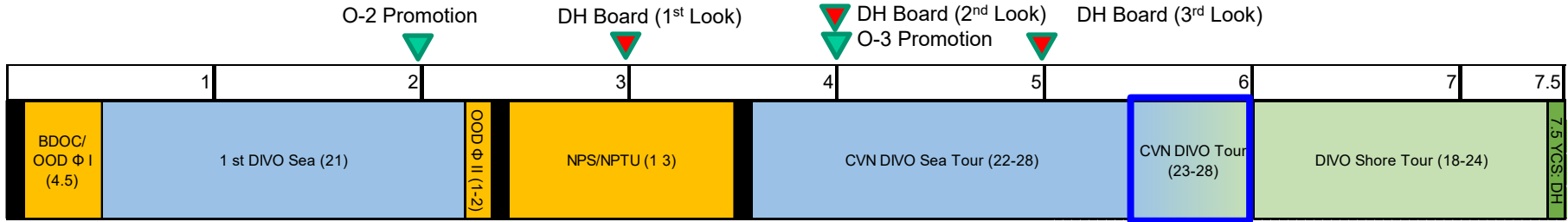

SWO(N) Career Path

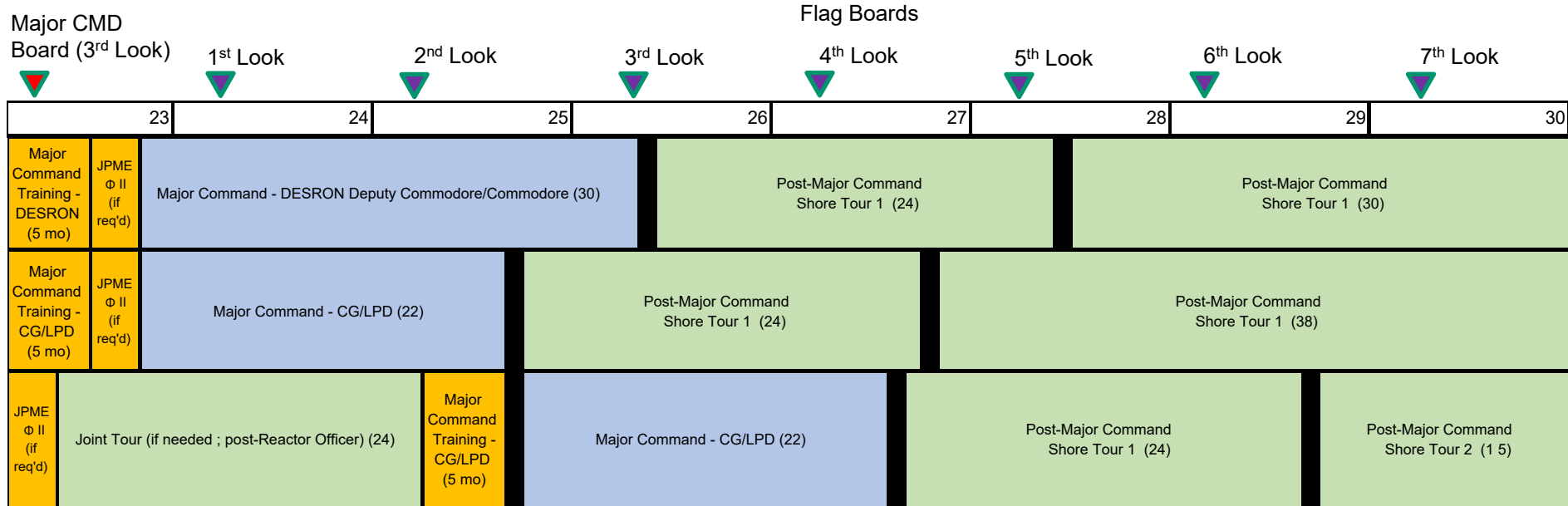

- Promotion Board
- Promotion
- Administrative Board
- Career Flexibility

SWO(N) Career Path



-  Administrative Board
-  Flag Board

First Division Officer Tour

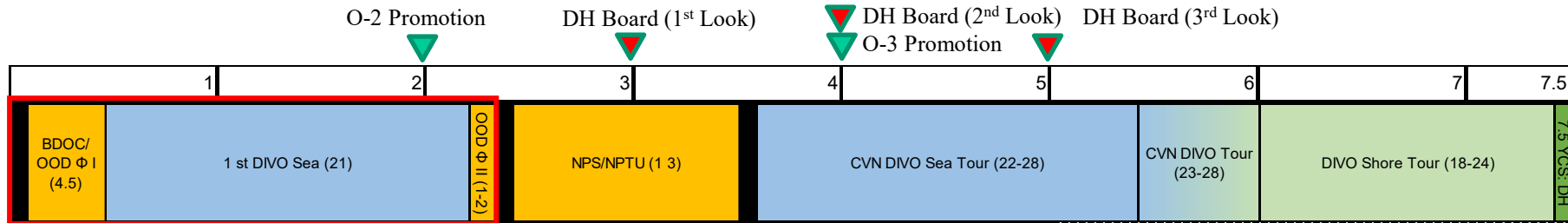

- **BDOC + OOD Phase I + 21 Month Conventional DIVO Tour + OOD Phase II**
 - Detailed to operational tour to earn OOD/SWO quals:
 - Gain shiphandling/navigation experience
 - Build maritime warfare/tactical skillset
 - Earn DH Afloat recommendation
- SWO(N)s shall not serve in an Engineering tour IAW MPM 1301-223

Leading Sailors, Building SWO Skills!

Nuclear Power School



- Naval Nuclear Power Training Command (NNPTC) in Charleston, SC
- 3 Week Pre-School + Six month curriculum
 - Take three courses at a time (e.g. Math, Physics, Water Chemistry, Engineering, Power Plant Operations, etc.)

WEEKS																									
1	2	3	4	5	6	7	8	9	10	11	12	13	14	15	16	17	18	19	20	21	22	23	24		
Mathematics						Electrical Engineering												Core Characteristics						Comprehensive Exam	
RPS	Heat Transfer and Fluid Flow									Reactor Dynamics						Materials			Radiological Fundamentals						
Physics									Chemistry						Aspects of Reactor Plant Operations										

Nuclear Training Pipeline



O-2 Promotion

DH Board (1st Look)

DH Board (2nd Look)

DH Board (3rd Look)

O-3 Promotion

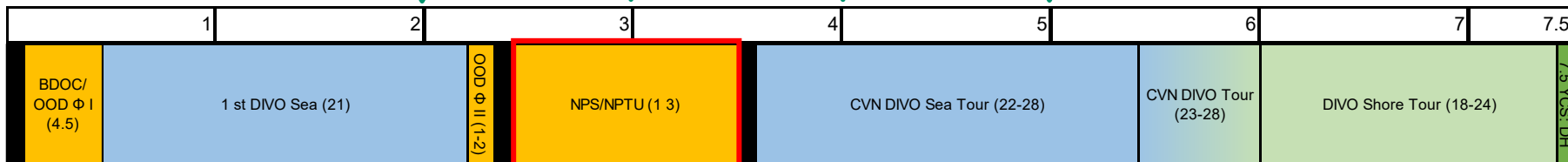

- 7 months at Nuclear Power School in Charleston, SC
 - Includes a 3 week pre-school, mandatory for all SWO(N)s
- 6 months at Prototype in Charleston, SC or Ballston Spa, NY
- Same nuclear training as submarine community and CVN Executive Officers

Challenging and Rewarding Graduate-Level Training!

Surface Nuclear Fleet



G. WASHINGTON (CVN 73)

YOKOSUKA

RONALD REAGAN (CVN 76)

BREMERTON

NPTU

Ballston Spa, NY

JOHN C STENNIS (CVN 74)

- Conducting refueling overhaul

JOHN F. KENNEDY (PCU 79)

- New construction

NEWPORT NEWS, VA

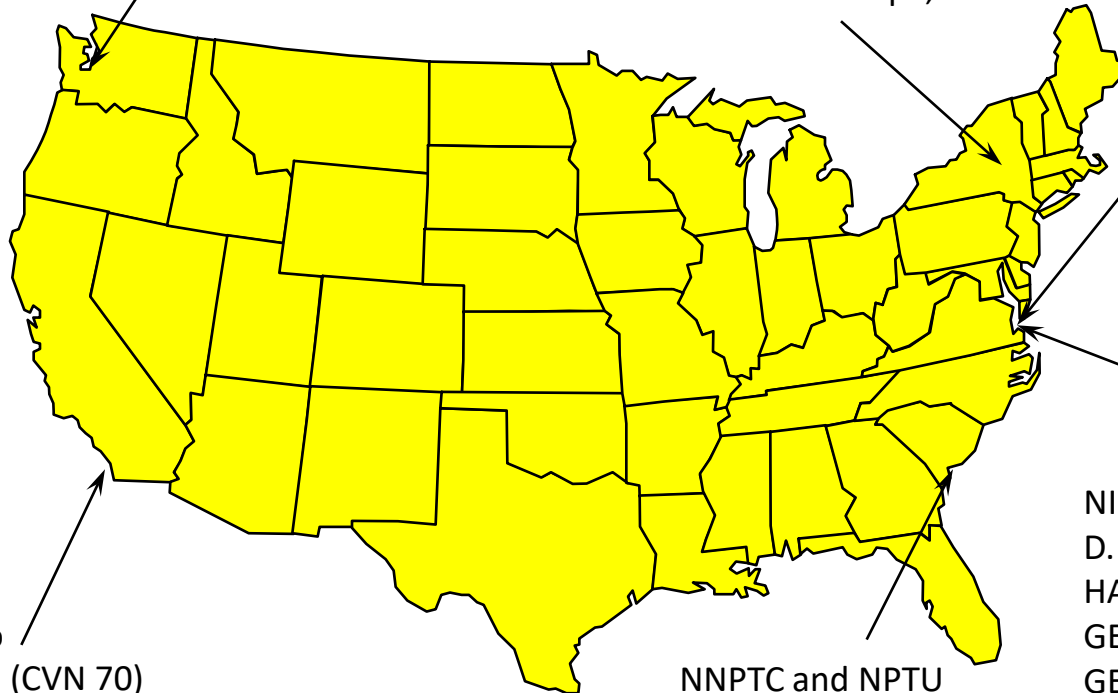

NORFOLK, VA

NIMITZ (CVN 68)

D. D. EISENHOWER (CVN 69)

HARRY S TRUMAN (CVN 75)

GEORGE H BUSH (CVN 77)

GERALD R FORD (CVN 78)

SAN DIEGO

CARL VINSON (CVN 70)

THEODORE ROOSEVELT (CVN 71)

ABRAHAM LINCOLN (CVN 72) HPS to BREM JUN 2026

NNPTC and NPTU

Charleston, SC

CVN Divo Experience

A4W: CVN 68-77

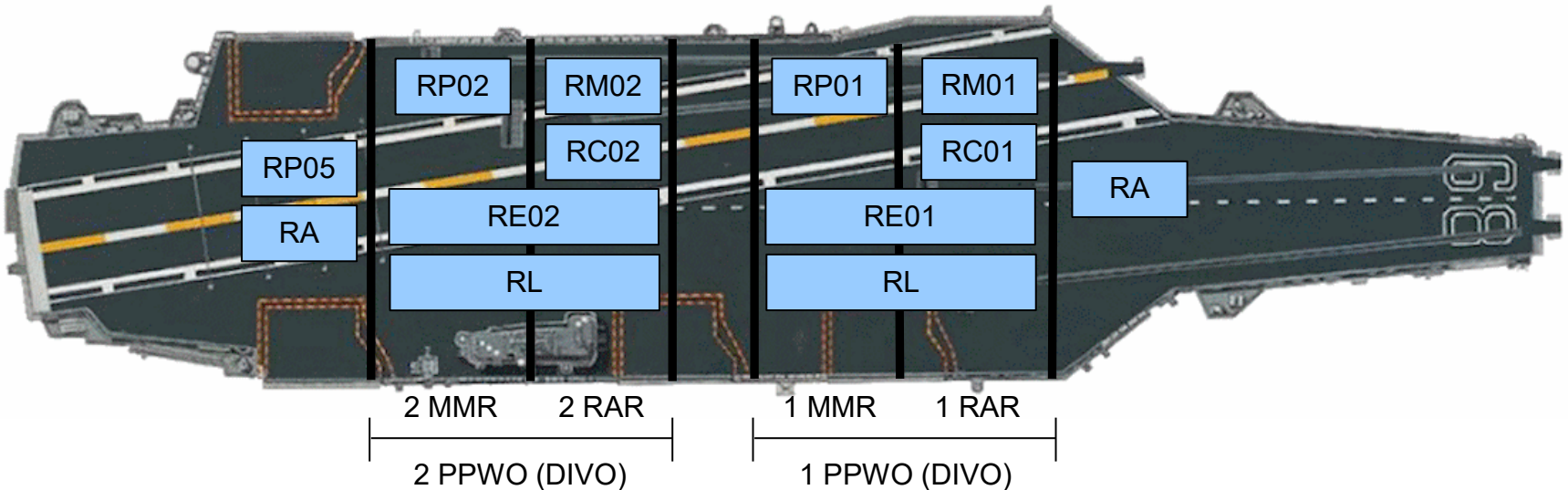
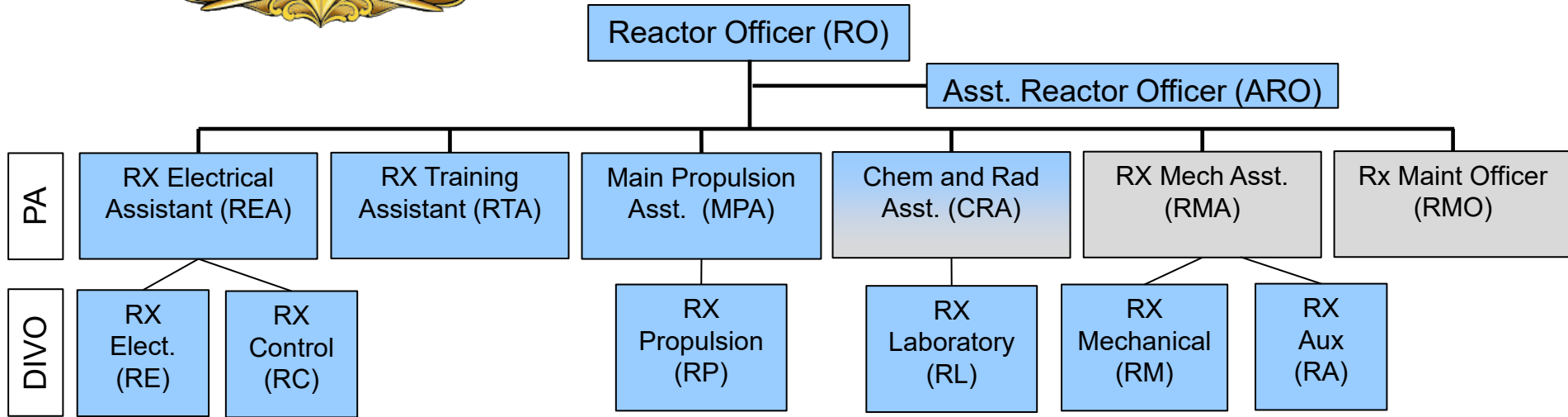

EOW (PA/Senior DIVO)

CVN Divo Experience

A1B: CVN 78 & Above

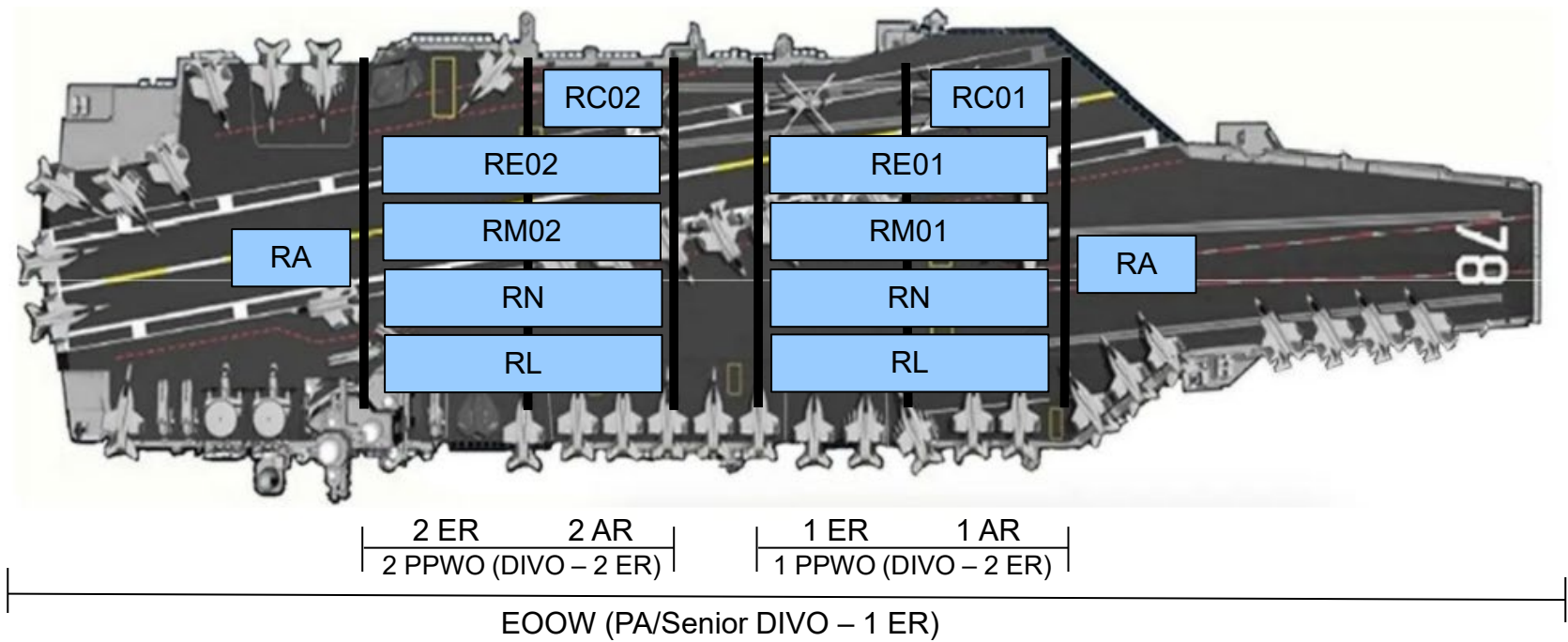
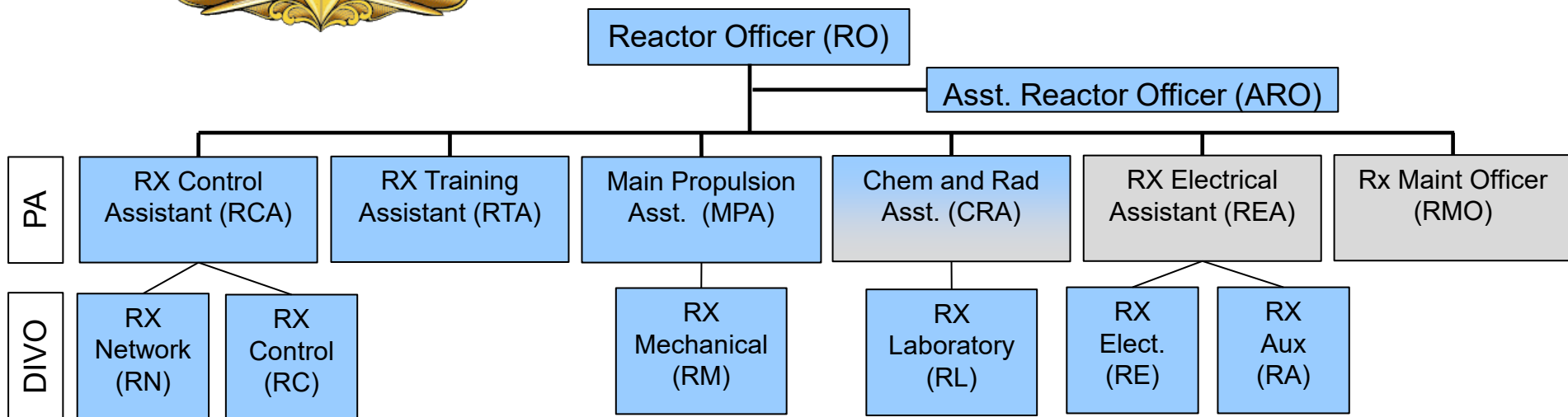

Second Division Officer Tour

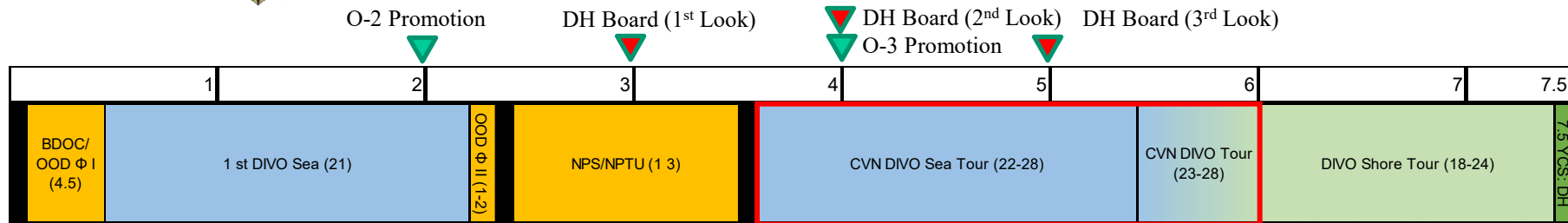

– Qualify PPWO & Qualify NEO

– 28 Month CVN DIVO Tour

- May be reduced to 22 months if:
 - Complete PNEO and take orders as NPTU Shift Engineer, or
 - Signs a DHRB contract and
 - » Successfully completes PNEO
 - » Accrues a minimum of 4 months aboard post-PNEO
 - » Reactor Officer concurs with early transfer
- May be reduced to 25 months if:
 - Accepts follow-on orders to shore duty and meets the 3 requirements above

Lead Sailors, Operate and Maintain the Plant!

Department Head Screening

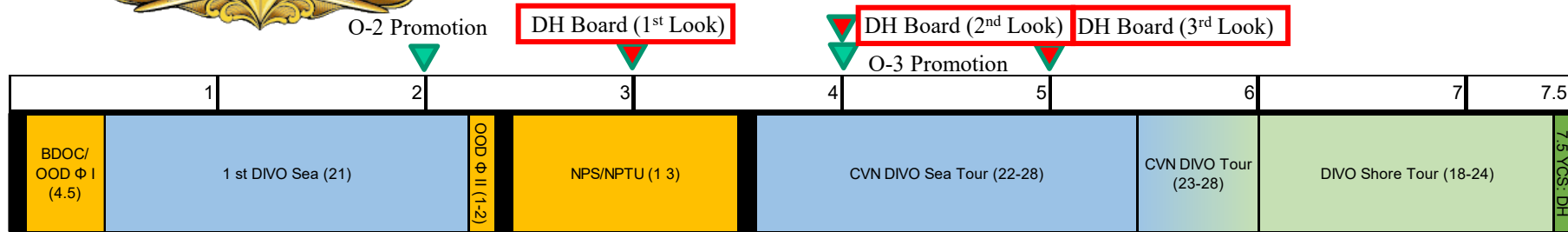

- Department Head Screening Board - YCS 3, 4, 5
- Factors that contribute to screening:
 - SWO Pin (**required**)
 - DH Recommendation in Block 40 (**required**)
 - At or Above CO's RSCA / Summary Group AVG
 - Soft Breakouts in Block 41
 - No Declining Performance
 - No PFA Failures
 - No legal issues / pending investigations

DH Board moved to April!

First Shore Tour – Max Flexibility!



Talent Management Board

- Every August – awards high demand/profile
- No penalty to apply! You decide to accept awarded program

Nuclear Shore Tours

- Jobs that give you nuclear experience credit
- Slate directly with me! No commitment until awarded billet

SWO(N) Required Jobs

- NROTC units have 1 nuclear trained officer
- Compete against SUB officers

Conventional Shore Slate (WTI available)

- Commit to shore upon submitting preference sheet
- Slate calculation used to determine selection order (DHRB to top)

Goals:

1. Recharge
2. Masters
3. JPME I

Competitive Shore Slating with Increased Billet Selectivity!

Talent Management Programs



- Board conducted **annually** in the summer. Contact your detailer for specific timing.
- **Don't need to be a DHRB signer to compete**
- Applications require:
 - willingness to sign DHRB (required to accept billet)
 - a letter indicating the programs you wish to apply for
 - a letter of endorsement from your Chain of Command
 - any other special reqs...GPA, GRE

Programs include:

- USNA LEAD/Company Officer
- SECNAV Tours with Industry
- Purdue Military Research Initiative (PMRI)
- Georgia Tech Research Initiative (GTRI)
- Massachusetts Institute for Technology/Woods Hole (MIT-WHOI)
- Professional Exchange Program (PEP) (England, Canada, Spain, France, Australia, Italy, Belgium, Portugal, etc)
- Naval Reserve Officer Training Corps (NROTC)
- Naval Postgraduate School (NPS)
- Olmsted Scholar
- Graduate Education Voucher (GEV)

Exceptional Opportunity, NO Risk!

First Shore Tour – Max Flexibility!



Talent Management Board

- Every August – awards high demand/profile
- No penalty to apply! You decide to accept awarded program

Nuclear Shore Tours

- Jobs that give you nuclear experience credit
- Slate directly with me! No commitment until awarded billet

SWO(N) Required Jobs

- NROTC units have 1 nuclear trained officer
- Compete against SUB officers

Conventional Shore Slate (WTI available)

- Commit to shore upon submitting preference sheet
- Slate calculation used to determine selection order (DHRB to top)

Goals:

1. Recharge
2. Masters
3. JPME I

Competitive Shore Slating with Increased Billet Selectivity!

SWO(N) Shore Requirements



Post Division Officer, O-3 (33)

NR A4W/A1B Fleet LT* (3)
NPTU Ballston Spa (1-2)
NPTU Charleston (4-5)
NNPTC Charleston (7)
MTT Lant MTT LT (1), PNEO (2)
MTT Pac MTT LT (1), PNEO (1)
MTT PNW PNEO Coord (1)
OPNAV N133 Nuclear Programs* (1)
CNRC NTO (6)

- Millington, TN (2)
- San Diego, CA (1)
- Norfolk, VA (1)
- Mayport, FL (1)

NSTC ROTC Coord (1)
PERS 412O, JO/New Acc Detailer (1)*
USNA SEANAV Billet (1)*

* DHRB Required

Post PA, O-4 (20)

CNAP CVN N43 Maint. Desk (1)
CNAL CVN N43 Maint. Desk (1)
CNAL/CNAP FRTA (2)
MTT Deputy Lant (1) and Pac (1)
NPEB Lant (2) and Pac (2)
NPTU BSPA MTS XO (1)
NPTU Charleston MTS XO (1-2)
NNPTC DOD (1)
NR Exec Asst./Tech Asst. (2)
OPNAV N133, Program Mgr (1)
PERS 412N, JO/PA Detailer (1)
PERS 42D1, Community Mgr (1)
NPTU Charleston
Student Control Officer (1)

Post ARO, O-5 (6)

MTG Det Yoko OIC (1)
MTG Det Bremerton OIC (1)
CNAL N9 MTG OIC (1)
NPTU Charleston Site XO (1)
NPTU Charleston ITG Dir (1)
NIMITZ DECOM Coord (1)

Post Commanding Officer, O-5 (4)

MTT Lant/Pac OIC (2)
NPTU Ballston Spa CO (1)
PERS 424 (1)

Post Reactor Officer, O-6 (4)

CNAL/CNAF N9 (2)
NR Line Locker (1)
CNAP N9 Det Bremerton (1)

Numerous and Diverse Options for Nuclear Shore!

NPTU Shift Eng Benefits



- 18 months as a Shift Engineer (vice normal 24 months)(DHRB only)
- **Up to** 12 months of dedicated study time (sabbatical)(DHRB only)
 - Masters Degree and/or JPME for 12 months prior to Department Head School
 - Protected sabbatical time w/ career flexibility – tour of significant value
 - Study plan submitted to NPTU XO
 - Potential to complete JPME/Grad Ed at Naval War College
- Commit to Shift Engineer early (~9 months)
 - Allows detailer enough time to identify a relief
 - **Reduces CVN DIVO tour to as short as 22 months**
- Shift Engineer Incentive Pay (SEIP)
 - **\$1000 per month bonus for the length of assignment (including sabbatical period)**
- **Silver Bullet for DH** slating (homeport, billet, or platform)

First Shore Tour – Max Flexibility!



Talent Management Board

- Every August – awards high demand/profile
- No penalty to apply! You decide to accept awarded program

Nuclear Shore Tours

- Jobs that give you nuclear experience credit
- Slate directly with me! No commitment until awarded billet

SWO(N) Required Jobs

- NROTC units have 1 nuclear trained officer
- Compete against SUB officers

Conventional Shore Slate (WTI available)

- Commit to shore upon submitting preference sheet
- Slate calculation used to determine selection order (DHRB to top)

Goals:

1. Recharge
2. Masters
3. JPME I

Competitive Shore Slating with Increased Billet Selectivity!

Career Flexibility: DH Tour Timing Options



**** Recommended COA ****

O-4 Board



O-4 Promotion



O-4 Spot Promotion



CDR CMD Board (1st Look, 2nd Look)



O-5 Board

CDR CMD Board (3rd Look)



O-5 Promotion

Nominal DH:
7.5 YCS

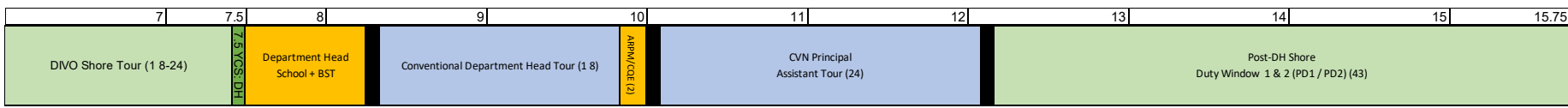

Early DH:
6 YCS



Delayed DH:
8 YCS

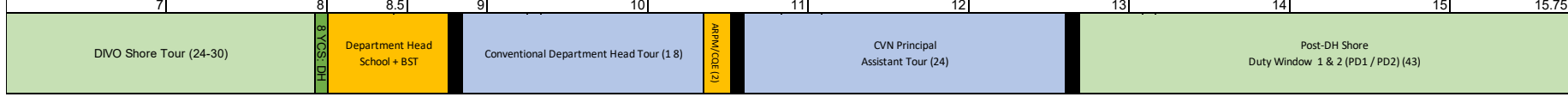

- **Early DH School**
 - Maximizes opportunities during post-PA shore duty window (PD1/PD2)
- **> 9 YCS AQD Removal**
 - Nuclear AQDs shall be removed effective an officer's 9 YCS anniversary date unless officer is due course, slated to a nuclear super-DIVO tour, or upon transfer from a nuclear-coded billet. Due course is defined as serving as or slated to serve as a department head of CVN PA.

Flexible DH timing is 5-8 YCS!

Resignations



- MPM 1920-190, 1920-200
- Submitted **9-12 months** prior to the desired separation date
- Expect separation orders **5-6 months** from approved separation date
- See PERS-451 website for more info: See Reference Page 2
Career management → Personnel Conduct & Sep → Officer Resignations
- All resignations/retirements submitted, routed and adjudicated **via NSIPS**
 - **Retirements must be submitted for the 1st of the month**
 - **Resignations must be submitted for the last day of the month**
- Detailer has the ultimate responsibility for determining obligated service and dates concerning resignation

Communicate Early with Detailer!

Lateral Transfer



- Managed by **Year Group**
- Examples include: EDO(N), IP, HR, FAO, INTEL, IW, etc.
- EDO(N)
 - Should be pursued during CVN DIVO tour
 - Pursuing EDO(N) after CVN DIVO tour is possible but delays training and milestones required to screen O5
- Case-by-case exceptions for other communities:
 - Following PNEO qualification
 - When YG on track to meet PA requirements
- Board held every February and August
- Must be released by both SWO and SWO(N) community
- May apply for Tailored Community Transition (TCT) for lateral transfer to EDO, FAO, or MSO
 - Requires signing DHRB and serving as a DH and CVN PA
 - Able to keep SWO and Nuke bonuses through DH/PA tours
 - Tailored shore and DH tour and optional to accept lateral transfer or stay SWO(N)!
 - Requires TCT application to desired community prior to DH

Balancing Requirements and Desires with Needs of the Navy!

EDO(N) Program Career Path



Goal: Produce officers competitive for selection as Reactor Officer on a CVN in RCOH, Inactivation or New Construction

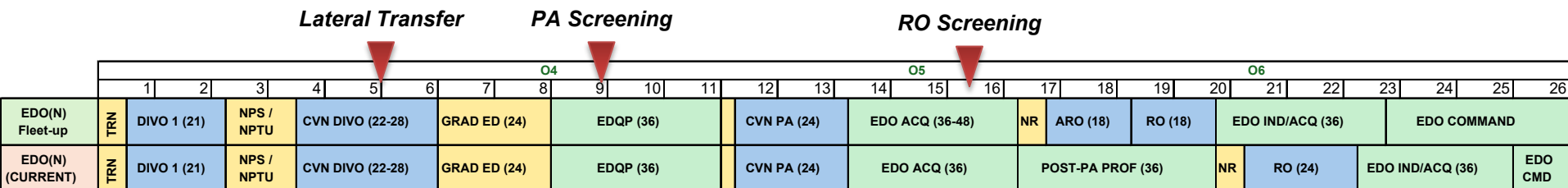

- PA Tour: preferentially detailed to CVN in RCOH / NEWCON / extended avail (DPIA)
- EDO(N)s are eligible for COBO (\$50k / year)
- EDO(N)s alternate between nuclear and non-nuclear tours

PA Screening Board



PA Screen Board

O-4 Promotion

CDR CMD Board (1st Look, 2nd Look)

CDR CMD Board (3rd Look)

O-4 Board O-5 Board O-5 Promotion

8	9	10	11	12	13	14	15	15.75
Department Head School + BST	Conventional Department Head Tour (1 8)		ARRM/CODE (2)	CVN Principal Assistant Tour (24)		Post-DH Shore Duty Window 1 & 2 (PD1 / PD2) (43)		

- Administrative Screening Board held in Millington
- Board occurs in spring **9-20 Months before your 1DH PRD**
- Keys to screening: Sustained superior performance during 1st DIVO tour, CVN DIVO tour, and nuclear shore duty (if applicable)

Improving Readiness through Selectivity!

Department Head/Principal Assistant Tours

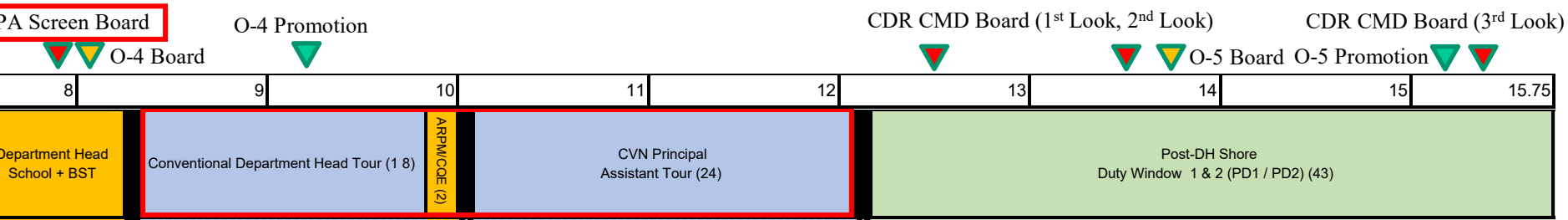

1DH Tour: 18 Months

- Options:
 - CSO (LPD/LHA/LHD)
 - 1st LT (LSD)
 - OPS (DDG/LSD)
 - WEPS (CG/DDG)
- Operational Detailing: Limits time in SY

Goals:

- Build topside and tactical experience during 1DH Tour
- Pass Command Assessment before PA Tour
- Build Nuclear experience prior to RO Tour

Performance in these tours is **VITAL** for future selection boards!

CVN PA Tour: 24 Months

- Options:
 - RTA, REA (A4W), MPA, RCA (A1B), and some CRA (all are spot promote)
- Slating timeline: ~7-10 months from 1DH PRD
- Attend ARPM & CQE following 1DH (SWCLA if possible, with timing)

Superior DH Performance Is Your Path to Command!

Command Qualification



- Governing instruction - CNSFINST 1412.7B (MAY 2025)
 - CQE Bibliography (12): See Reference Page 2
 - Updated Periodically on MyNavyPortal Website/ Intelink (takes 24 hours to activate)
- Requirements:
 - Minimum shipboard experience & complete Qual Card
 - Earn SWO, TAO, & EOOW qualifications
 - Pass Command Assessment (CA) - (SWOS)
 - Shiphandling and Tactical Scenarios
 - Examination: RoR, CM, MR, NSS, MW
 - Recommendation from an Afloat CO while serving afloat
 - Surface Warfare Command Leadership Assessment (SWCLA) replaces Command Oral Board (proactive scheduling required)

Best Practices:

- Finish PA tour SWCLA complete – **Qualifies you for CDR CMD Screening AND unlocks your detailing possibilities.**
- Ensure Qualification Card line items a-f are signed by your 1st DH CO prior to detaching for 1st DH tour
- Build shiphandling competence and confidence: Spend time in local shiphandling simulators prior to CA

Drive Your Future!

Commander Command Board



- CDR CMD Board timing will be anchored to YCS 12
 - 1st look YCS 12, 2nd look YCS 13, 3rd look YCS 15
- Dec 2026 CDR CMD Board Eligibles
 - 1st look: December following 12 YCS
 - YG14 officers (commissioned between 01 Oct 13 – 30 Sep 14)
 - 2nd look: December following 13 YCS
 - YG13 officers (commissioned between 01 Oct 12 – 30 Sep 13)
 - Remain eligible for CDR Command Afloat, XO Afloat, XO Afloat*, or XO-SM milestones
 - 3rd look: December following 15 YCS
 - YG11 officers (commissioned between 01 Oct 10 – 30 Sep 11)
 - XO Afloat, XO Afloat*, or XO-SM screened officers w/ CMD qual eligibility for CDR Command Afloat or CO-SM milestones
- SWO Acquisition Professional (AP)
 - Apply for AP Candidacy during your CDR CMD Board
 - Up to two SWO(N)s per board may be selected for SWO AP
 - May apply for AP Eligibility during semiannual board

Post-Principal Assistant Shore Tour

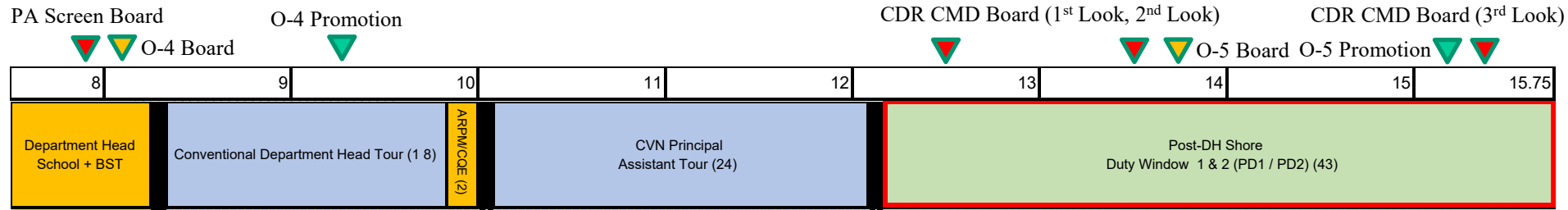

- PD1:
 - **Complete nuclear shore duty, if not yet complete**
 - First two looks for CDR CMD typically occur in PD1
 - Serve in SWO Community/OPNAV Staff Jobs to support CDR Command Screening
- PD2:
 - Complete JPME I, if not complete (a prerequisite for CDR Command)
 - Options determined by milestone-screening status at CDR Command Board
 - If screened CO Afloat – complete joint tour
 - If screened XO Afloat, XO Afloat*, or XO-SM, serve in milestone billet to improve chances of screening CDR Command Afloat or CDR Command-Special Mission

Complete Career Requirements and Broaden Skills!

Career Flexibility:

Post PA Shore Tour Timing Options

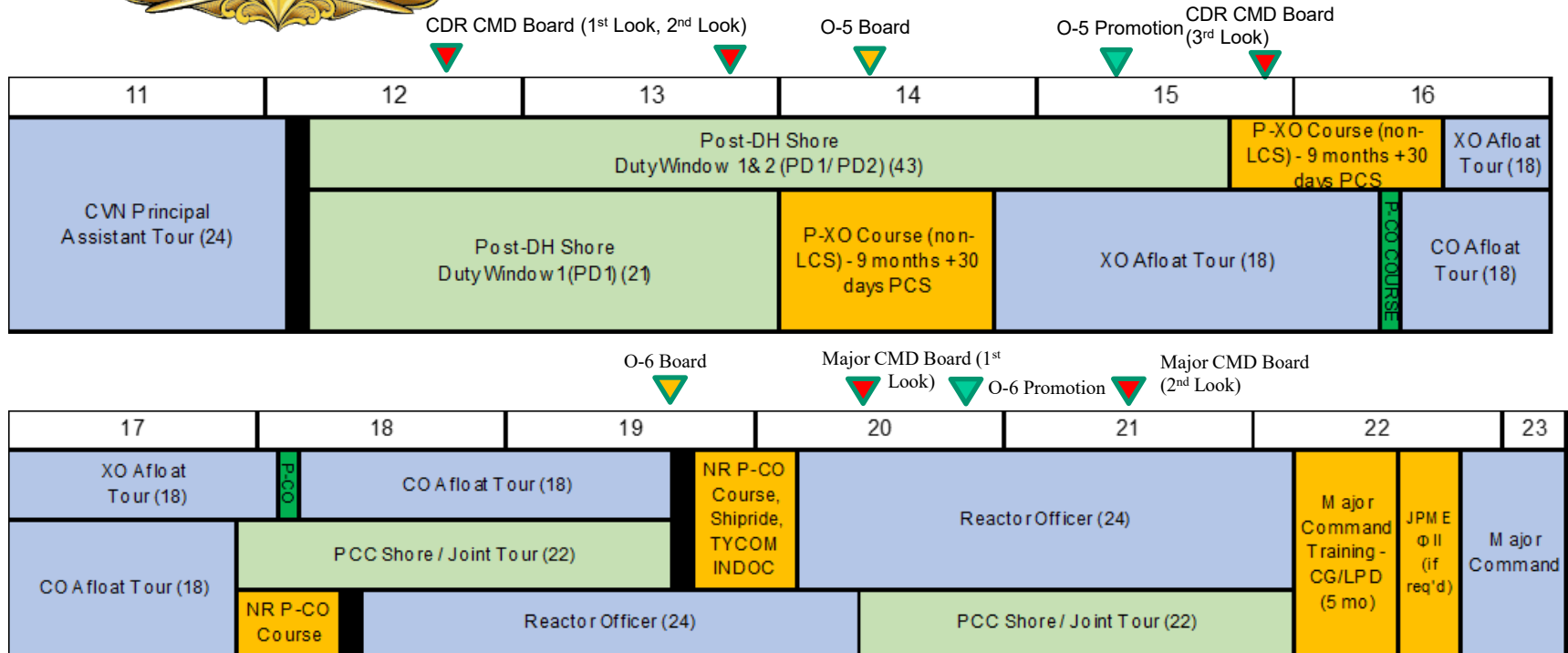

- **Early CO Tour**
 - Available to officers who select for CDR CMD in first or second look
 - Will delay reporting to XO until promoted to CDR
- **More Options Post Command**
 - Allows for breaks PCC or Post-RO before continuing to Major Command
 - RO inventory projections determine shore tour length - conversation with detailer is key

Continued Flexibility, Remain Competitive!

Career Flexibility: Nuclear Specialty Path



XO-Afloat*/Special Mission (XO*/SM) Screened Roadmap:

- XO*/SM screened officers are detailed to ARO for their next sea tour and considered an XO-milestone tour.
 - Post-ARO career path defined by 3rd look screening results.
- If the ARO-served officer does not screen for MAJCOM, they will execute nuclear shore duties during their post-ARO sea-shore rotation.

XO-Afloat Screened Roadmap:

- XO-Afloat screened officers choose either the “Nuclear Specialty” or “SWO(N)” path.
- “Nuclear Specialty” Path: Execute a notional 24-month ARO tour, post-ARO nuclear shore duty, and a 24-month RO tour.
 - This will be executed on a need-to-fill basis and quotas will be determined every year.
- “SWO(N)” Path: Execute an XO tour; RO eligible if screens CO-Afloat 3rd look or ARO (as required) if not CO-Afloat selected.

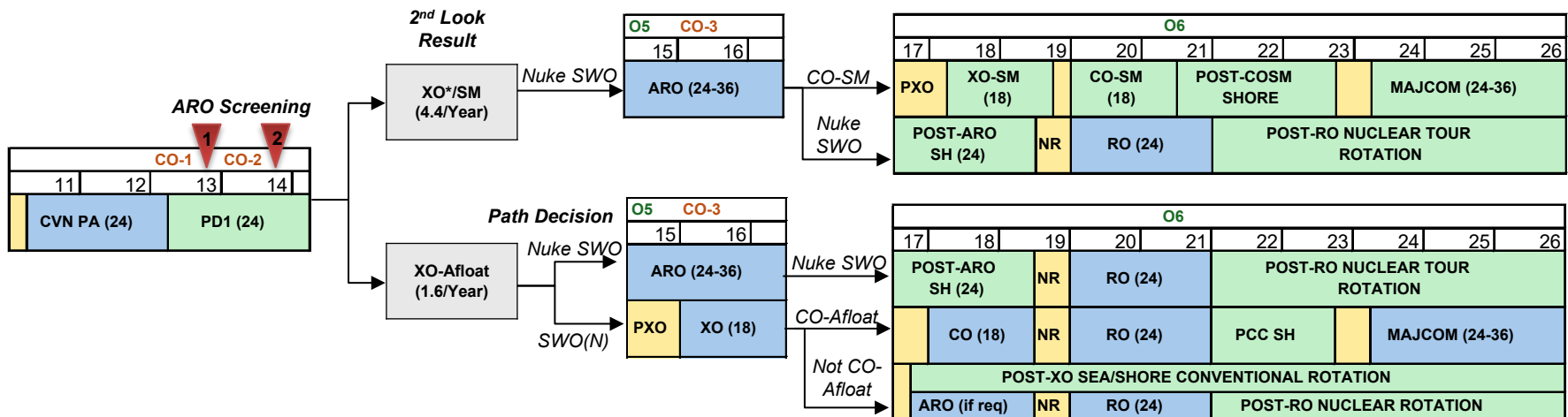

Career Flexibility: Naval Officer Specialization



Skill Areas/Portfolio Management

- Operational/Policy
 - Operations Analysis
- Resources/Requirements
 - Financial Management
- Personnel

Career Requirements

- JPME Phase I/II
- Master's Degree
- Joint Tour (COCOM, Joint Staff, etc.)
- SWO Community Tour (TYCOM, OPNAV N96, etc.)
- DC/Pentagon Tour (OSD/W, OLA, SECNAV, etc.)

SWO Bonuses and NOBIP



- Compensation For Two Skillsets
 - SWO: Warfighting Skills (DHRB/LRB/SORB)
 - NOBIP: Nuclear Talent (AIP/COBO/SEIP)
 - No interlock between SWO & Nuke Contracts

Bonuses: > \$1,676,000 during a 30 year career!

The Surface Warfare Family of Funds

Department Head Retention Bonus (DHRB)



- New DHRB rates are determined by commitment based on years of commissioned service (YCS)
- No longer tied to when officers screen for Department Head
- Must be screened for DH to sign
- Contract must be received **prior** to YCS anniversary to receive respective rate
- Legal restraints to DHRB:
 - Yearly payments cannot exceed \$25k
 - No payments past YCS-10
- Governed by NAVADMIN 149/24: See Reference Page 2

DHRB Payment Scheme						
		YCS-4	YCS-5	YCS-6	YCS-7	YCS-8
Contract Received Before	YCS-4	10K				
	YCS-5	15K	10K			
	YCS-6	25K	25K	20K		
	YCS-7	25K	25K	25K	25K	
	YCS-8	25K	25K	25K	25K	25K
	YCS-9	25K	25K	25K	25K	25K
	YCS-10	25K	25K	25K	25K	25K
	Total	\$150K	\$135K	\$120K	\$100K	\$75K

Up to \$500,000 Total Bonus for 2 DH Tours!

Nuclear Officer Bonus & Incentive Pay

(NOBIP)



- Continuation Bonus (COBO): up to \$60,000 Annually
 - Initial Contracts - \$50k/year
 - Renegotiated / Follow on Contracts - **\$50k/year**
 - Serving/Served Major Commanders to include fleet-up billets - \$60k/year for ≥ 2 year contracts (must obligate beyond Major Command for \$60K rate); 1-Year at \$50k (cannot sign consecutive 1-Year contracts)
- Annual Incentive Pay (AIP): \$12,500 Annually
 - Available at >10 YCS
 - Paid every 30 SEP for the previous fiscal year (\$22K for MC serving/served or O-6 w ≥ 26 YCS)
- Timing Considerations
 - Minimum contract length is 4 years for initial contracts prior to PA
 - Minimum contract length is 3 years post PA (1 year for Major Commanders)
 - **Renegotiate** if the rate goes up prior to your final COBO payment or to align the contract to your commissioning date
 - **Contact LCDR Michelli prior to submitting your contracts!**
- OPNAVINST 7220.11K and NAVADMIN 087/25

Compensation Reflects Value of Your Job!

The Surface Warfare Family of Funds

LCDR Retention Bonus (LRB)



- SWO LRB (up to \$66,000 over 3 payments)
 - Apply between 11 and 12 YCS (may apply early)
 - Must successfully complete 2 DH Tours (exception made if still on PA tour)
 - \$22,000 payment received on 12th, 13th, and 14th YCS anniversary
 - OBLISERVE is through completion of 15 YCS (one year after last payment)
 - COBO dates are either current contract date or commissioning date
 - Can align COBO to commissioning date to match obligation on most occasions
 - NAVADMIN 247/24: See Reference Page 2

**LCDRs: YOU MUST SUBMIT AN APPLICATION
PRIOR TO 12 YCS!!**

\$266,000 Total Bonus for 2 Lcdr Shore Tours!

The Surface Warfare Family of Funds

Senior Officer Retention Bonus (SORB)



- SWO SORB (up to \$48,000 over 4 payments)
 - Apply between 18 and 19 YCS (may apply early)
 - Must be permanently appointed O5 serving in or complete with milestone tour (XO/CO Fleet-up, XO-A, XO-A*, XO-SM)
 - \$12,000 payment received on 19th, 20th, 21st, and 22nd YCS anniversary
 - OBLISERVE is through completion of 23 YCS (one year after last payment)
 - COBO dates are either current contract date or commissioning date
 - Can align COBO to commissioning date to match obligation on most occasions
 - NAVADMIN 026/25: See Reference Page 2

**CDRs: YOU MUST SUBMIT AN APPLICATION
PRIOR TO 19 YCS!!**

\$248,000 Total Bonus for RO Tour

SWO(N) Retirement Compensation



- BRS retirement pay as a Commander (O-5) at 20 years yields \$46,675 annually before taxes not including cost-of-living adjustment (COLA)
- Veteran's benefits (VA health care, VGLI, potential disability pay)
- Retirement in mid-40s or able to earn a second retirement if desired
- Does not account for time at USNA or continued service (SORB, O-6 retirement pay, major command COBO)
- Consider the value and flexibility of a guaranteed income after working only 20 years, not an option anywhere in the civilian sector
- <https://militarypay.defense.gov/Calculators/Blended-Retirement-System-Standalone-Calculator/>

Significant Post-Career Compensation!

SWO(N) Career Monetary Compensation



SWO(N) Take-Home vs Equivalent Civilian Pay

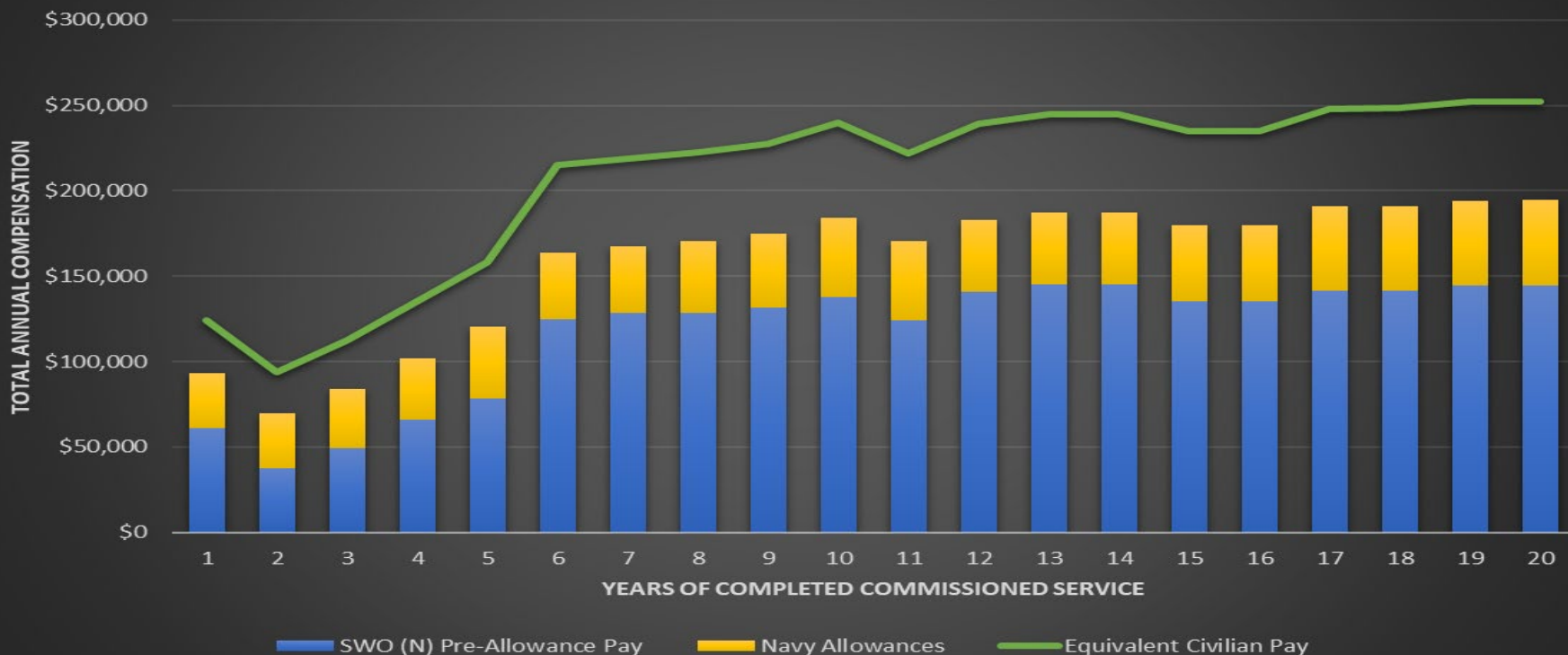

- Based on 2025 Pay Chart and Allowances (Norfolk Dependent BAH)
- Equivalent Civilian Pay (Green Line) represents the civilian offering salary required

Civilian Sector Needs \$50K+ to Match Us!

Your Service Record



- **Qualifications** Detailers can update quals & AQDs (e.g.):
 - OOD (LB2)
 - SWO (LA9)
 - LA5 (DH screened and signed)
 - PPWO/PNEO (KD1/2)
 - CVN EOOW (LC5)
 - TAO (LF6/7)
 - ECO (BS1/BS2)
 - ASWE (BA1/BA2)
 - BMDO (BM1)
- **Picture** – Get it done each time you promote. Required in your record. Update via BOL.
- **Record Management Tools:**
 - Officer Record Management guide: See Reference Page 3
 - “Board Prep” Ready Reference posted on SWO(N) webpage: See Reference Page 3
- **PFA – PRIMS**
- **Awards – NDAWS**
 - Command Award Authority updates (YN/PS)
 - OSR pulls from NDAWS
- **FITREPS – sent to PERS-32**
 - **1 of 1** – resubmit, or email detailer if missing
 - **Competitive** – must be submitted by command
- **My Record**; view your record (OMPF-My Record) and ODC/OSR/PSR via Bupers Online or My Navy Portal – MyRecord

It's YOUR Record, Own It!

Statutory Board Considerations



- Ensure promotion recommendation included in Block 41
- Screening status is not part of record – the FITREP must tell the board what the Community has decided
- Lead FITREP bullets should read:
 - MAJOR COMMAND: **Screened Major Command**
 - CO-Afloat screened officers: **Screened Commander Command Afloat**
 - CO-SM screened officers: **Screened Commander Command**
 - XO-Afloat screened officers: **Screened for Executive Officer Afloat**
 - XO-SM screened officers: **Screened for Executive Officer**
 - DH screened officers: **Screened for Department Head**
 - DH screened officers w/contract: **Screened for Department Head/DH Contract Signed**

Document Success at Sea to Support Promotion!

Key FITREP Points



FITREPS:
 Know the reference!
 (BUPERSINST 1610.10E)

What's the message:

- Hard break out?
- Soft break out?
- Caught in traffic?
- Boss's RSCA?
- Recommendation?
- Progression?
- Air gap?

Block 41 must tell a clear story – can you lead at the next level?

White space GOOD!

IT IS CRITICAL that your most recent community screening be clearly articulated in block 41 of **every** FITREP until you **actually serve in that milestone billet**.

40. I recommend screening this individual for next Recommendations may be for competitive schools SCP, Dept Head, XO, OIC, CO, Major Command, Recommendation → CDR COMMAND AFLOAT 4-STAR EA

41. COMMENTS ON PERFORMANCE: * All 1.0 marks, three 2.0 marks, and 2.0 marks in Block 34 must be specifically substantiated in comments. Comments must be verifiable. Font must be 10 or 12 Pitch (10 or 12 Point) only. Use upper and lower case.

***** #1 OF 7 ROCKSTAR DEPARTMENT HEADS!! *** ← Soft Breakout**
***** EARNED HIS FULL COMMAND QUALIFICATION! READY TO COMMAND AT SEA TODAY!! *****

Continues to demonstrate what it takes to COMMAND AT SEA! He is the perfect combination of professional competence, brilliant leadership, and warfighting/shiphandling prowess.

- **COMMAND LEADER.** Will is THE best definition of multifaceted talent: CSO, SRA Coordinator, SWO, acting XO – no job is too big for him to tackle and excel! Expertly led maintenance effort in Yokosuka to repair our SONAR dome and get us home after an extended deployment.

- **EXPERT SHIPHANDLER.** My best ship handler on board – period. I have full trust in his ability to steer STOCKDALE through the most challenging scenarios. He leads his bridge team with exacting standards while keeping the calm demeanor of a seasoned Captain.

- **TOP-TIER TACTICIAN.** Understands the capabilities of our combat suite and drives his team to maximize our ship's potential. My best TAO and CSTT leader, he's the one I want in the seat at the tip of the spear!

***** [REDACTED] EARNED MY FULL CONFIDENCE – GIVE HIM A SHIP AND CONTINUE TO PROMOTE EARLY! *****
*****ATTN FY26 CDR CMD BOARD: DON'T HESITATE – THIS IS A FIRST-LOOK SELECT! PRESS 100 NOW!*****

Promotion Recommendation	NOB	Significant Problems	Progressing	Promotable	Must Promote	Early Promote	44. Reporting Senior Address
42. INDIVIDUAL						X ← Hard Breakout	
43.			0	1	1	1	

43. Signature of Reporting Senior
 Date: _____

46. Signature of Individual evaluated. "I have seen this report, been apprised of my performance, and understand my right to submit a statement."
 I intend to submit a statement. I do not intend to submit a statement.

Member Trait Average: 5.00 Summary Group Average: 4.86

Compare to Boss RSCA

Career Tools



- SWO(N) Newsletter
- SWO(N) Grams (stay in the loop on shore duty – send us your e-mail address)
- SWO(N) Instagram
- SWO(N) Facebook Mentorship Network Page
- SWO(N) Webpage on MyNavyHR
- FITREP Rules of Road

- www.mynavyhr.navy.mil
- **PERS41_SWO_NUC_WARRIORS (PERS41_SWO(N)_WARRIORS)**
- **SWO(N) Facebook Mentorship Network Group: Search “SWO(N) Mentorship Network” on Facebook or see Reference Page 3**
- www.facebook.com/PERS41
- **Call Customer Service: (833) 330-MNCC**

Stay Engaged in SWO(N) Community!

Career Path Education Initiatives



- PERS-41 YouTube Videos:
 1. 1DV to 2DV Slating
 2. Career Path Overview
 3. 2DV to Shore Slating
 4. Talent Management Board
 5. 1DH Slating
 6. O-4 Statutory Board
 7. 2DH Slating
 8. Reconciliation Process
 9. DH Board
 10. Commander Command Board
 11. Major Command Board
 12. Debrief Best Practices
 13. Detailer Handoff from ENS to CAPT
- Quarterly Facebook Live Sessions
- Career Path Planning Tool available on MyNavyHR
- Eight hours of record management and board process curriculum added to the P-XO and P-DH SWSC curriculums taught by PERS-41 personnel

PERS-41
YouTube

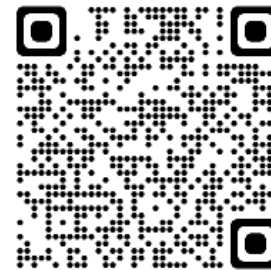

PERS-41
Facebook



Empowering your career ownership and improving process transparency!

Points of Contact



PERS 41N/424

CAPT Justin Smith

SWO(N) Programs and Placement

Justin.B.Smith3.mil@us.navy.mil

PERS 412N

LCDR Dyuti Das

SWO(N) Detailer

Dyuti.das.mil@us.navy.mil

PERS 42D1 / 424A

LCDR Audrey Michelli

SWO(N) Programs Administration and Execution

Audrey.michelli.mil@us.navy.mil

OPNAV N133C2

LCDR Brian Danley

SWO(N) Program Manager

Brian.J.Danley.mil@us.navy.mil

PERS 412O

LT Matt Ponzi

SWO(N) 1st Tour Divo and New Accessions Detailer

Matthew.j.ponzi.mil@us.navy.mil

NSIPS & NFAAS – Keep your contact information up to date please!

Takeaways



- Competitive slating + personalized executive detailing
 - Detailing Team is your career support staff!
- Rewarding and community valued work/jobs
- Strong financial compensation for challenging and demanding work
- Nuclear shore duty early adds flexibility later
- Diligently maintain YOUR record
- NEVER HESITATE TO CONTACT US!!!

Know Your Career Path! We are here to Help!

Questions?





Career Flexibility - Promotion Deferment:

- Promotion Deferment NAVADMIN (132/22):

<https://www.mynavyhr.navy.mil/Portals/55/Messages/NAVADMIN/NAV2022/NAV22132.txt?ver=xeRgJEMk4XzzhaQ-o28fPw%3d%3d> Active Duty Officer

- Promotion Boards webpage:

<https://www.mynavyhr.navy.mil/Career-Management/Boards/Active-Duty-Officer/>

- Promotion Board Deferment Guidance:

[https://www.mynavyhr.navy.mil/Portals/55/Boards/Active%20Duty%20Officer/documents/PSB_Deferment_\(Opt-Out\)_Policy_Implementation_Procedural_Guidance-Final_\(27_Sep_2019\).pdf](https://www.mynavyhr.navy.mil/Portals/55/Boards/Active%20Duty%20Officer/documents/PSB_Deferment_(Opt-Out)_Policy_Implementation_Procedural_Guidance-Final_(27_Sep_2019).pdf)

Career Flexibility - Career Intermission Program:

- OPNAVINST 1330.2C (Navy CIP Guidelines):

<https://www.secnav.navy.mil/doni/Directives/01000%20Military%20Personnel%20Support/01-300%20Assignment%20and%20Distribution%20Services/1330.2C.pdf>



Resignations – PERS 451 Website for Resignations

<https://www.mynavyhr.navy.mil/Career-Management/Personnel-Conduct-Sep/Officer-Resignations/>

Command Qualification – CQE Bibliography 12 (Note: Works best on Google Chrome – needs 24 hours to update)

<https://inteldocs.intelink.gov/folders/list/8f7ed25b-c616-4ebe-a353-279cbeaae608>

NOBIP – NAVADMIN 087/25

<https://www.mynavyhr.navy.mil/Portals/55/Messages/NAVADMIN/NAV2025/NAV25087.pdf?ver=z8aSMUSX-l8jjidaPBwXFpQ%3d%3d>

SWO DHRB – NAVADMIN 149/24

https://www.mynavyhr.navy.mil/Portals/55/Messages/NAVADMIN/NAV2024/NAV24149.txt?ver=bV_qTOGYMNJPh39UfxJ-fw%3d%3d

SWO LRB – NAVADMIN 247/24

<https://www.mynavyhr.navy.mil/Portals/55/Messages/NAVADMIN/NAV2024/NAV24247.txt?ver=COQweppAv7lrJG7li6YHpw%3d%3d>

SWO SORB – NAVADMIN 026/25

<https://www.mynavyhr.navy.mil/Portals/55/Messages/NAVADMIN/NAV2025/NAV25026.txt?ver=yMfuONC82kOiqZeVfvt7hA%3d%3d>



Your Service Record

- Officer Record Management guide

https://www.mynavyhr.navy.mil/Portals/55/Career/Detailing/Officer/StaffCorps/Supply/Officer%20Record_Management_Brief.pdf?ver=RfJDbeqq90N_7VUBp2iqxA%3D%3D

- “Board Prep” Ready Reference posted on SWO(N) webpage

https://www.mynavyhr.navy.mil/Portals/55/Career/Detailing/Officer/StaffCorps/Supply/Officer%20Record_Management_Brief.pdf?ver=RfJDbeqq90N_7VUBp2iqxA%3D%3D

Career Tools

- MyNavyHR SWO(N) Webpage:

<https://www.mynavyhr.navy.mil/Career-Management/Detailing/Officer/Pers-41-SWO/Detailers/SWO-N/>

- SWO(N) Facebook Mentorship Network Group:

<https://www.facebook.com/groups/1890240891100295/>